

EL260 EL2100 EL2150 EL460 EL1500 MA460

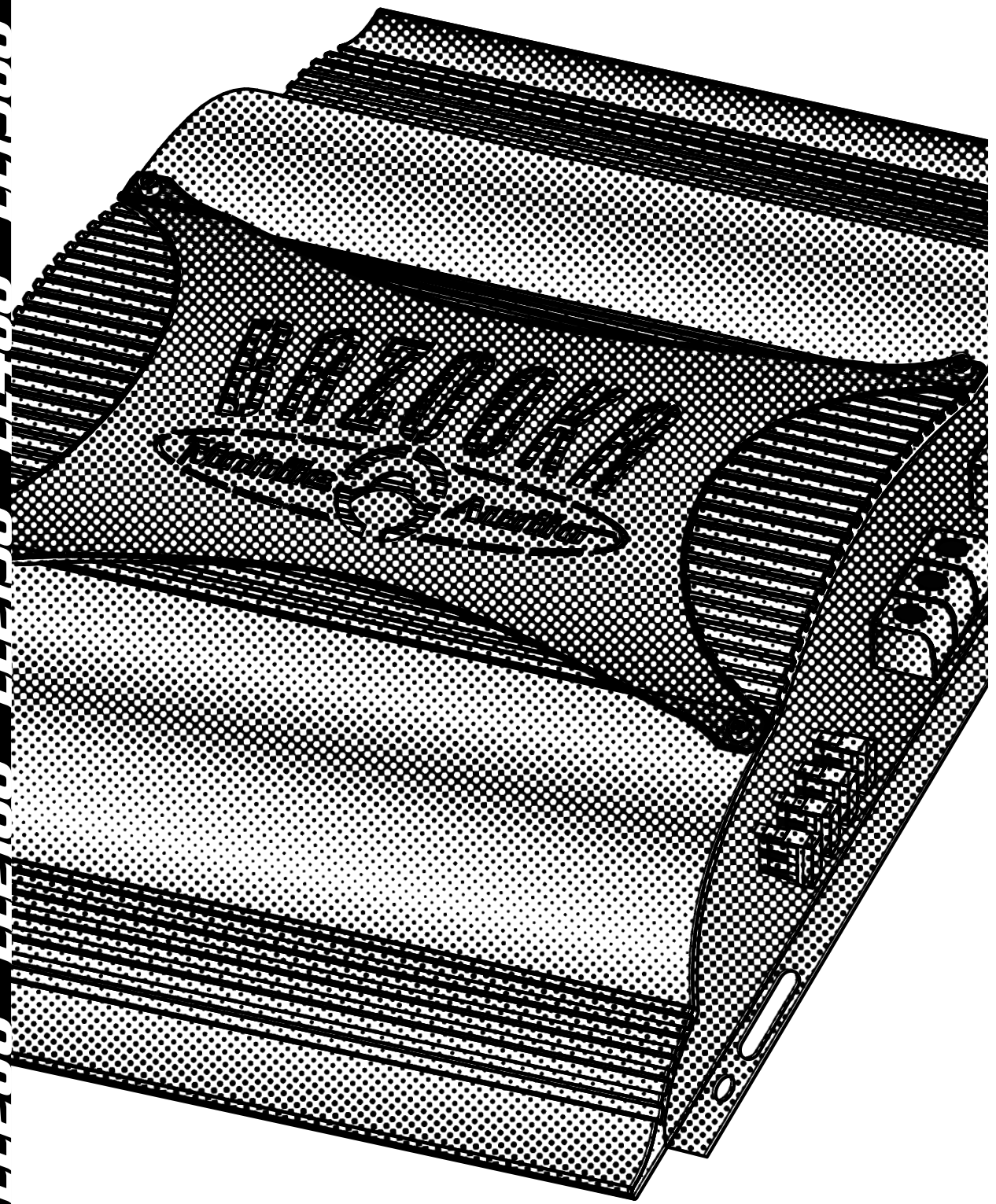

EL AMPLIFIERS



Installation Manual

Dear customer,

Congratulations on your purchase of a Bazooka EL high-performance amplifier. At Bazooka, we are fanatics about accurate music reproduction. Your selection of our products for your sound system indicates that quality sound is also important to you too. At SAS, we take great pride in manufacturing revolutionary audio products, and through the years of engineering expertise, hand craftsmanship and critical testing procedures, we have created the EL high-performance series of amplifiers. We hope that you will take as much pride in owning and using one of these high-quality audio products as we do designing and manufacturing them.

When properly installed and operated, your Bazooka EL amplifier will give you years of clean uninterrupted sound reproduction. Therefore, we urge you to take a few minutes to carefully read through this manual. It will explain all of the features of your EL amplifier and help insure trouble free installation.

Sound can be deceiving. Over time your hearing comfort level adapts to higher volumes of sound. What may have sounded normal can actually be too loud and harmful to your hearing. Guard against this by setting your equipment at a safe level before your hearing adapts.

To establish a "safe level",

- Start with your volume control at a low setting.
- Slowly increase the volume control until you can hear comfortably, clearly and without distortion.
- Once you have established a comfortable "sound level", make a note of this position and do not go above this setting

Taking a minute to do this will help prevent your hearing from being damaged and allow you to enjoy listening to music throughout your lifetime.

SAFETY PRECAUTIONS

Fuse amplifiers power wire at the battery.

Be sure to fuse the power wire within 12" of the car's battery. This will protect the car's battery in case of a short circuit between the power amplifier and battery. THIS IS A MUST, the amplifier's built-in fuse will only protect the power amplifier not the car's battery!

Use high grade wire connectors.

To ensure maximum power transfer and secure safe connections, it is recommended to use high grade barrier spades (for connection at amplifier) and terminal rings (for connection at battery).

Do not run any wires underneath vehicle.

Exposed wires have a chance of being cut or damaged. It is best to run all wires through the vehicle under the carpet and/or side panels. This lends to a cleaner installation and less risk of damage.

Use caution when mounting amplifier.

Remember there are many electrical wires, gas lines, vacuum lines, brake lines as well as a gas tank in the automobile. Make sure you know where they are when mounting the amplifier to avoid puncturing lines, shorting wires or drilling holes in the gas tank.

Run signal wires away from electrical wires.

To avoid possibility of induced noise from the car's electrical system (i.e. popping noises or engine noise), run wires away from the car's electrical wiring.

Make all ground wires as short as possible and at the same point.

In order to reduce the chance of ground loops (i.e. engine noise), make the grounding wire as short as possible to reduce the wire's resistance. Also, when using multiple components, make sure all units are grounded at the same point.

Avoid sharp edges when running the wires.

To avoid the possibility of power, signal or speaker shorts, be careful not to allow the amplifiers wires to come in contact with sharp edges. Use a grommet to protect the wire when running through the fire wall.

FEATURES AND BENEFITS

DC Offset Protection

This circuit protects the output of the amplifier against DC voltage. If for some reason DC voltage is detected at the output stage, the amplifier will shut down protecting the speakers from direct current.

Short Circuit Protection

The circuit protects the amplifier from damage due to a short found in the speakers or wiring. If one of the speakers or its wiring comes in contact with ground, the amplifier will shut down. To resume normal operation, correct the problem and turn the head unit off, then back on. The amplifier will reset and play again.

Thermal Protection

To protect the amplifier circuitry against damage caused by prolonged exposure to high temperatures, a thermal protection circuit is activated if the amplifier reaches excessively high operating temperature. Once the thermal circuit is activated, the amplifier will shut down to cool off. The amplifier will automatically turn back on once it cools down to a safe operating temperature.

Power Indicator

The diagnostic L.E.D. Illuminates green when the amplifier is on and receiving power.

Tri Mode Capable

If so desired, the amplifier may be run in stereo and mono at the same time. For example, this feature would allow you to run a pair of mid and tweeters in stereo and a sub-woofer mono.

Built-in Crossover

The "EL" amplifiers include a built-in variable **high and low pass crossovers. The crossover features a variable frequency selection (60Hz ~ 400Hz) for precise high or low pass filtering. **Except EL1500 which has a 40 ~ 120Hz low pass filter.

Auxiliary Output

The "EL" amplifiers include a auxiliary output for a daisy chain connection of an EL Bazooka® Amplified Bass Tube.

Power and Speaker Distribution Blocks

Heavy gauge bare wire distribution blocks are provided for maximum power and signal transfer with minimal resistance.



Bass Boost

For added low frequency performance the amplifiers are equipped with a variable 0~12 dB bass boost @ 45Hz.

Line Out (EL 1500 Only)

One set of full range line outputs have been provided for convenient connection to additional amplifiers in the system.

Power Fusing

This protects the amplifier against short circuits and excessive current.

Remote Turn-on

Automatically turns amplifier on when connected to the head unit's remote output. The amplifier will turn on and off with the head unit to save current consumption. This control also operates the reset circuit for the amplifier's protection. It must be connected with the head unit in order to reset protection circuits.

Adjustable Input Sensitivity

Allows you to fine-tune the level matching between your source and the power amplifier.

High Level Input (EL260, EI460, EL2100 AND EL2150)

Allowing for integration with "Factory Sound Systems".

Stable To 2 Ohm Stereo Mode

Stability to 2 ohm in stereo mode, 4 ohms bridged. The EL 1500 is stable to 2 ohms mono.

MOUNTING LOCATION

Before you start the installation, it will be necessary to find a mounting location for the amplifier. Find a location in which the amplifier will receive adequate ventilation in order to dissipate the heat it develops during operation. Two popular mounting locations are in the trunk or under the seat.

Select the location in which you wish to mount the amplifier. Use caution when mounting amplifier, there are many wires, gas lines, vacuum lines, brake lines as well as a gas tank in the automobile. Make sure you know where they are when mounting the amplifier to avoid puncturing lines, shorting wires or drilling holes in the gas tank. Once you are ready, use a pencil to mark the mounting holes in the bottom panel. After you have marked the locations of the holes move amplifier out of the way and drill small starter holes to make the tapping screws easier to install. Use provided screws to tighten down the amplifier.

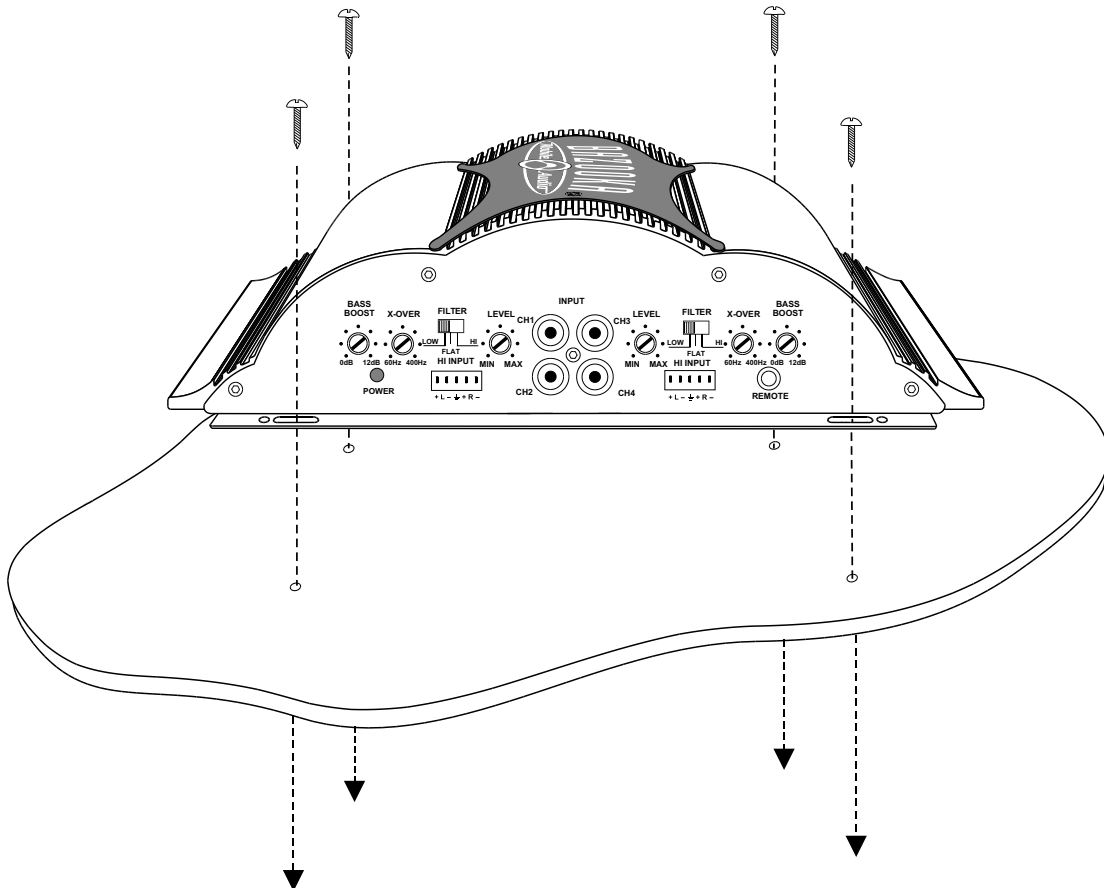

POWER CONNECTIONS

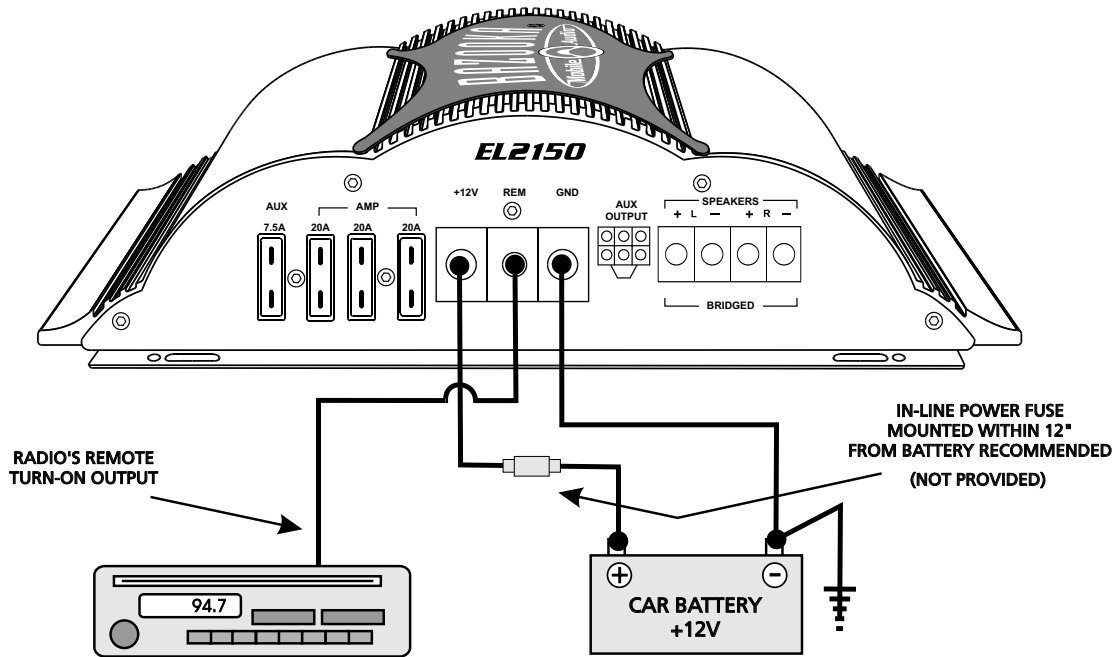

IMPORTANT! Before making any connections, disconnect the car's battery until the installation is completed to avoid possible damage to the electrical system.

Connect the amplifier to the car's battery.

At times, the amplifier will need to draw large levels of current that cannot be provided by any circuit in the car's fuse box. We recommended using an 4 to 8 gauge power wire for your connections depending on the amplifier and length of the wire. Strip one end of the wire to connect to the terminal on the amplifier marked +12V. Loosen screw terminal and connect bare wire and tighten. Use caution to make sure no stray wire stands come in contact with surrounding terminals causing short circuits. Run the wire directly to the positive terminal of the car's battery. Make sure to use an in-line fuse within 12" of the car's battery to protect the electrical system and amplifier against short circuits and/or power surges.

Connect the ground terminal of the amplifier to the car's chassis.

For the ground connection, use an 4 to 8 gauge wire (black) to connect to the terminal marked GND and then connect it to the car's chassis. Try to keep the length of the cable as short as possible, preferably less than 6". Also make sure that the point on the car where the connection is to be made is free of paint and dirt.

Connect the remote terminal of the amplifier to a switchable +12V source.

This connection allows the amplifier to be turned on and off with the power control of the radio. If the radio has a REMOTE output terminal, connect it to the amplifier's terminal marked REMOTE (using a 16 gauge wire or heavier). Now when the radio is turned on, the amplifier will automatically turn on. This connection can also be made to the radio's Power Antenna wire.

SIGNAL CONNECTIONS

Connect the RCA output of the head unit (AM/FM cassette player, CD, or DAT) to the RCA input terminals of the amplifier.

To make these connections, we recommend high quality RCA cables, which are available at your local car audio retailer. Run signal wires away from electrical wires to avoid possibility of induced noise from the car's electrical system (i.e. popping noises or engine noise). Please note that when making these connections the signal inputs correspond with the speaker outputs. For example: If you connect the radios front right RCA to "CH 1"then speaker output "CH 1" will operate the front right speaker.

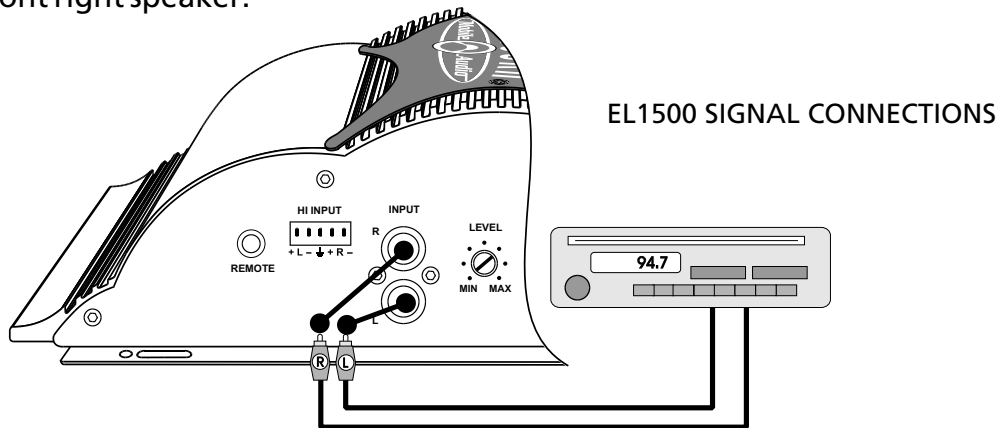

Optional full range line out connection to additional amplifiers in the system.

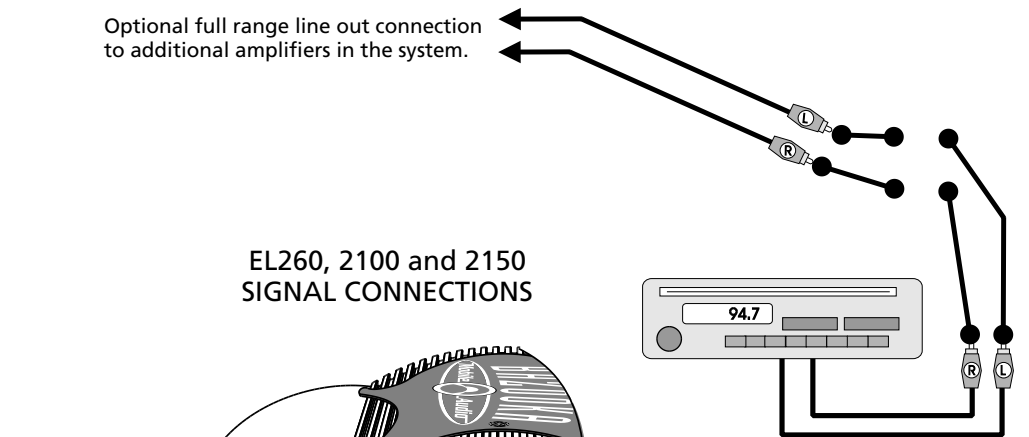

EL260, 2100 and 2150
SIGNAL CONNECTIONS

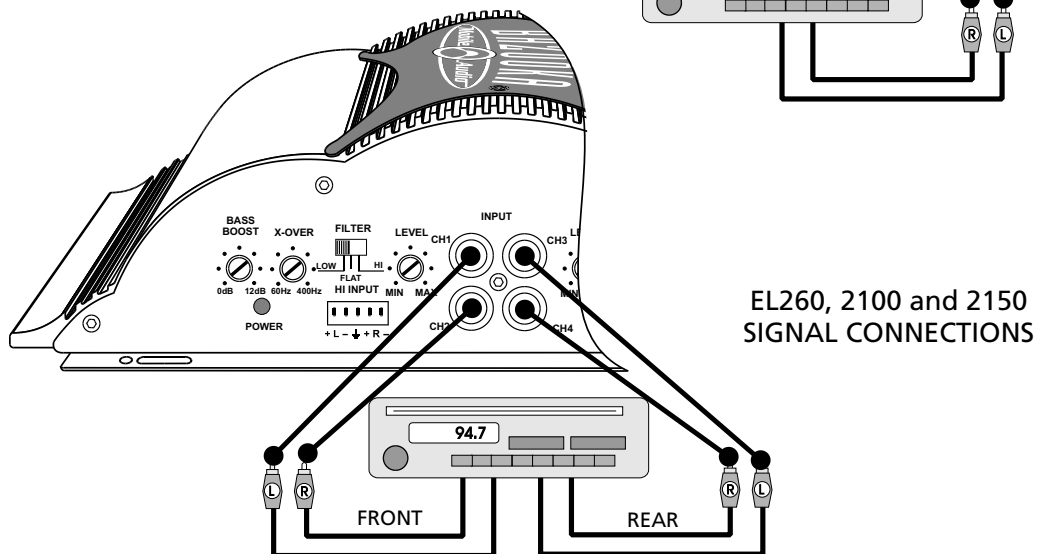

HIGH LEVEL CONNECTIONS (OPTIONAL)

High Level inputs have been included to connect the amplifier to a radio without low-level outputs (i.e. factory radio). This connection will allow you to connect directly to the speaker output of the radio with out the need of an external adapter.

Determine the type of radio you have and make one of the following connections.

CAUTION! Before making any connections determine the type of radio to avoid possible damage to amplifier and/or radio.

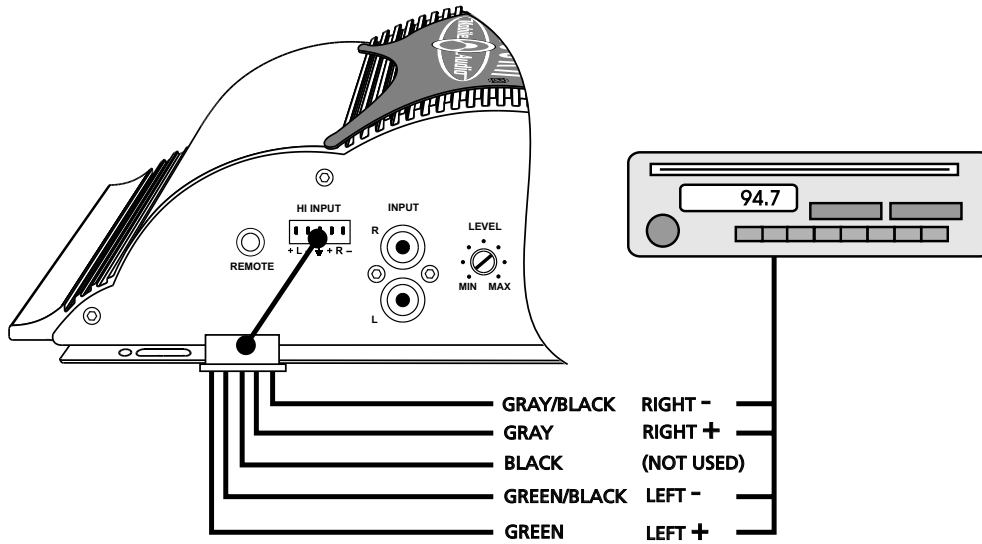

TWO CHANNEL CONNECTIONS:
FLOATING GROUND RADIO (MOST COMMON TYPE)

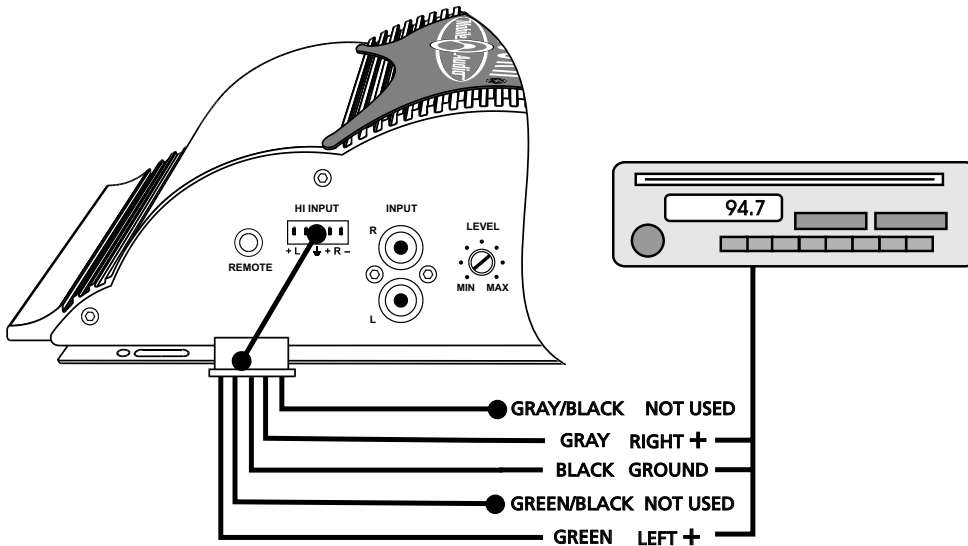

TWO CHANNEL CONNECTIONS:
COMMON GROUND RADIO

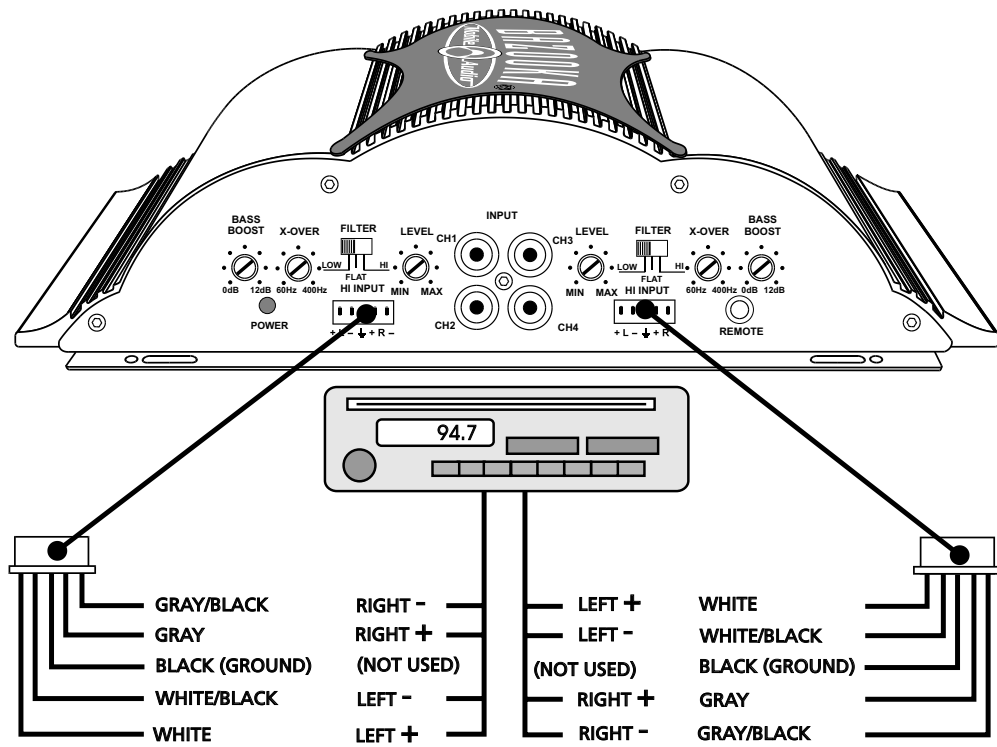

EL460 CONNECTIONS:
FLOATING GROUND RADIO (MOST COMMON TYPE)

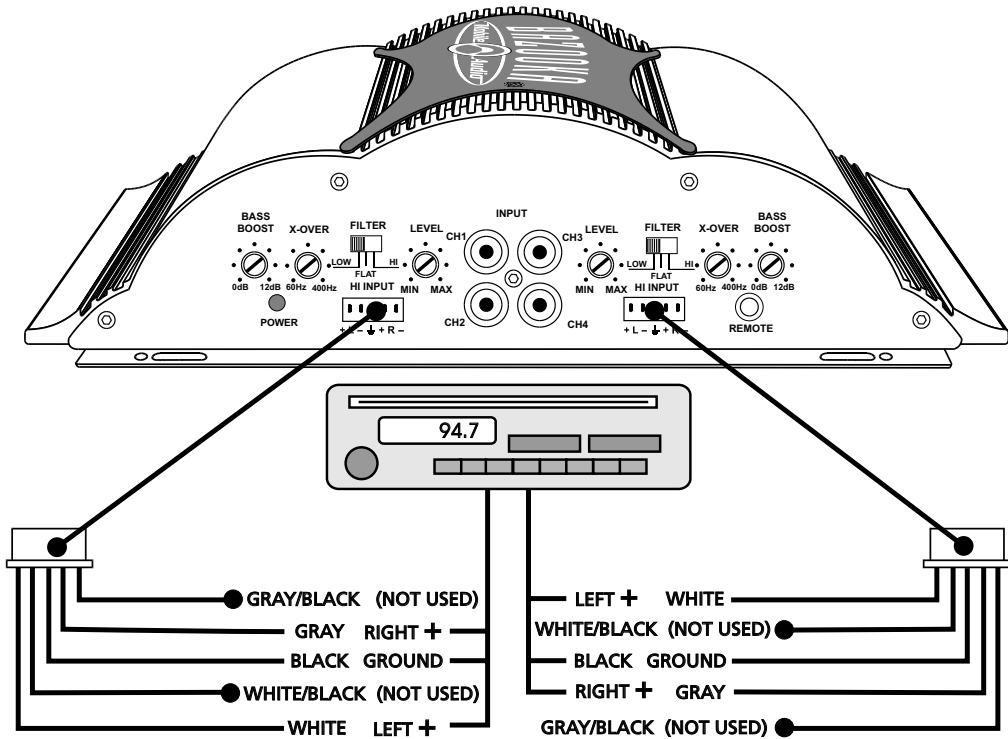

EL460 CONNECTIONS:
COMMON GROUND RADIO

SPEAKER CONNECTIONS

Make the speaker connections using speaker wire that is at least 16 gauge or heavier.

As with any audio component, proper phasing of the amplifier and speakers is essential for strong bass response. When connecting, make sure that positive (+) from the amplifier is connected to the positive (+) of the speaker, and the same for negative (-).

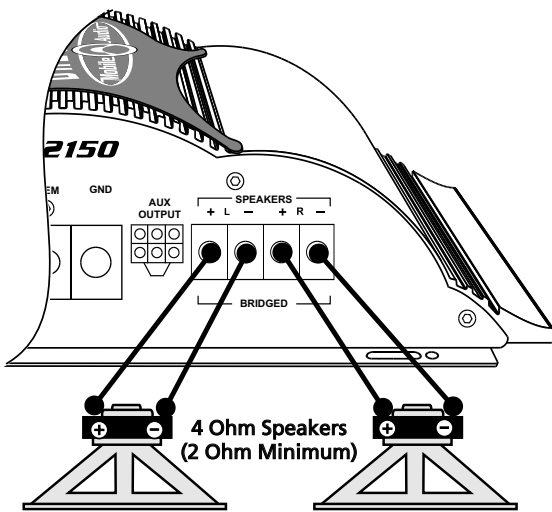

TWO CHANNEL
SPEAKER CONNECTIONS

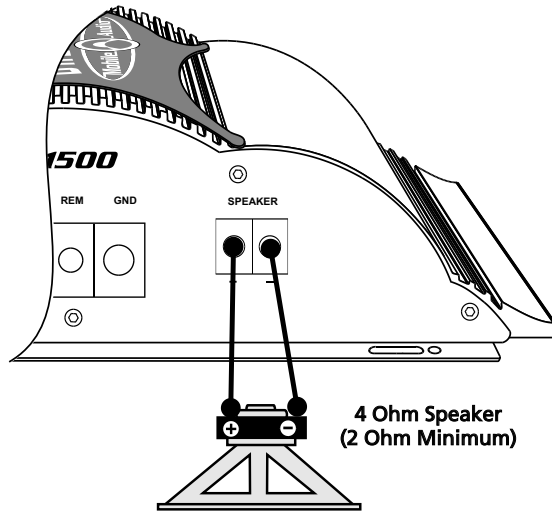

EL1500 SPEAKER CONNECTIONS

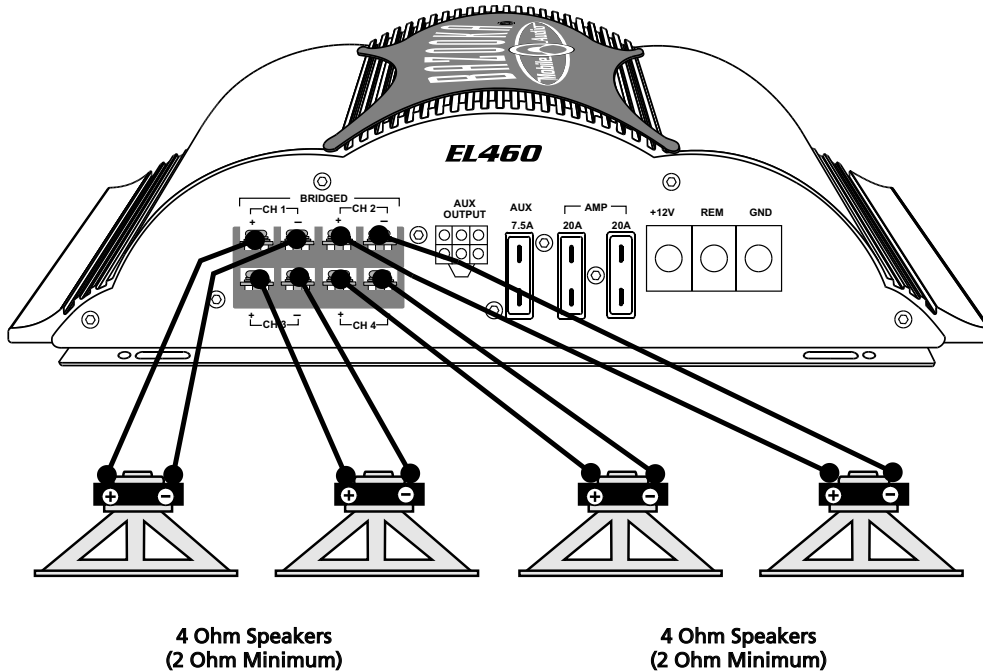

FOUR CHANNEL SPEAKER CONNECTIONS

SPEAKER CONNECTIONS (BRIDGED)

The EL amplifiers are capable of being bridged in a mono configuration. This feature allows you the flexibility of using the amplifier to drive a ** subwoofer or a center channel. In this configuration the amplifier sums the right and left channel to deliver one channel (mono) output.

Please note: in order for the amplifier to sum right and left signal information, both right and left RCA connections must be made.

****CAUTION!** In the bridged mode, the amplifier must see a 4 Ohm load or higher. Any lower than 4 Ohms will cause the amplifier to overheat and possibly cause

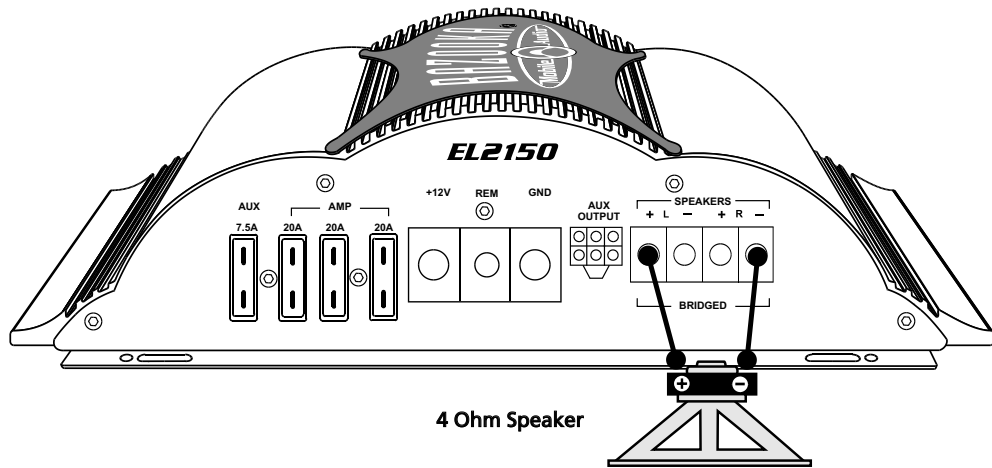

TWO CHANNEL BRIDGED SPEAKER CONNECTIONS

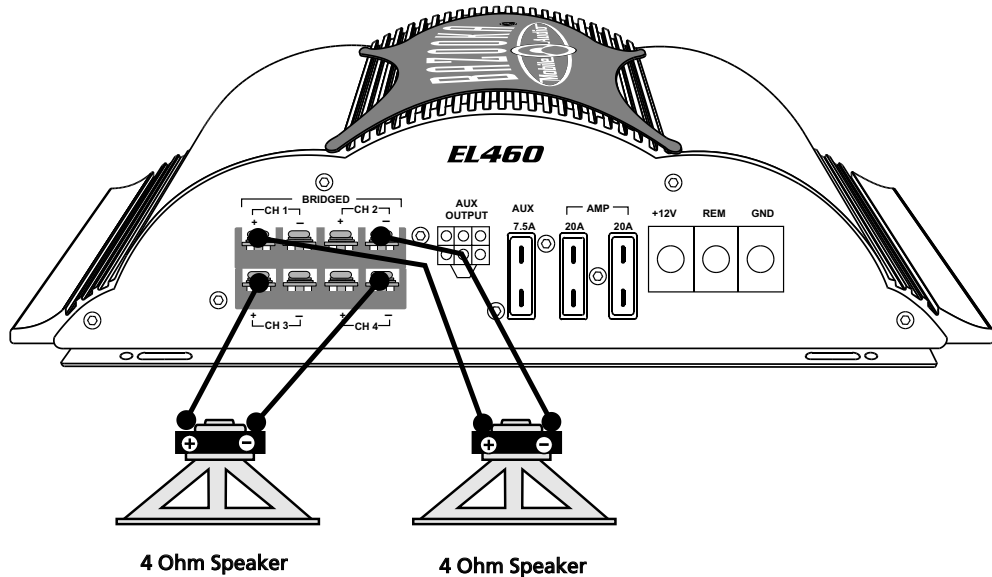

FOUR CHANNEL BRIDGED SPEAKER CONNECTIONS

SPEAKER CONNECTIONS (TRI-MODE)

The amplifier is capable of running in a Mono / Stereo mode. This feature gives the amplifier the ability to run stereo satellites (midbass & tweeter) simultaneously with a mono subwoofer.

These connections are more complicated because they require the use of passive crossover networks (Not provided) to divide the frequencies to the speakers. We have included a sample diagram for 4 Ohm connections. If you wish to use multiple speakers to achieve a lower impedance and higher power, it is strongly recommended that you seek professional advice from your BAZOOKA® retailer before attempting to make these connections.

Please Note: In the Tri-mode configuration, the amplifier's built-in crossover must be set to the "FLAT" position so the speakers receive full range output.

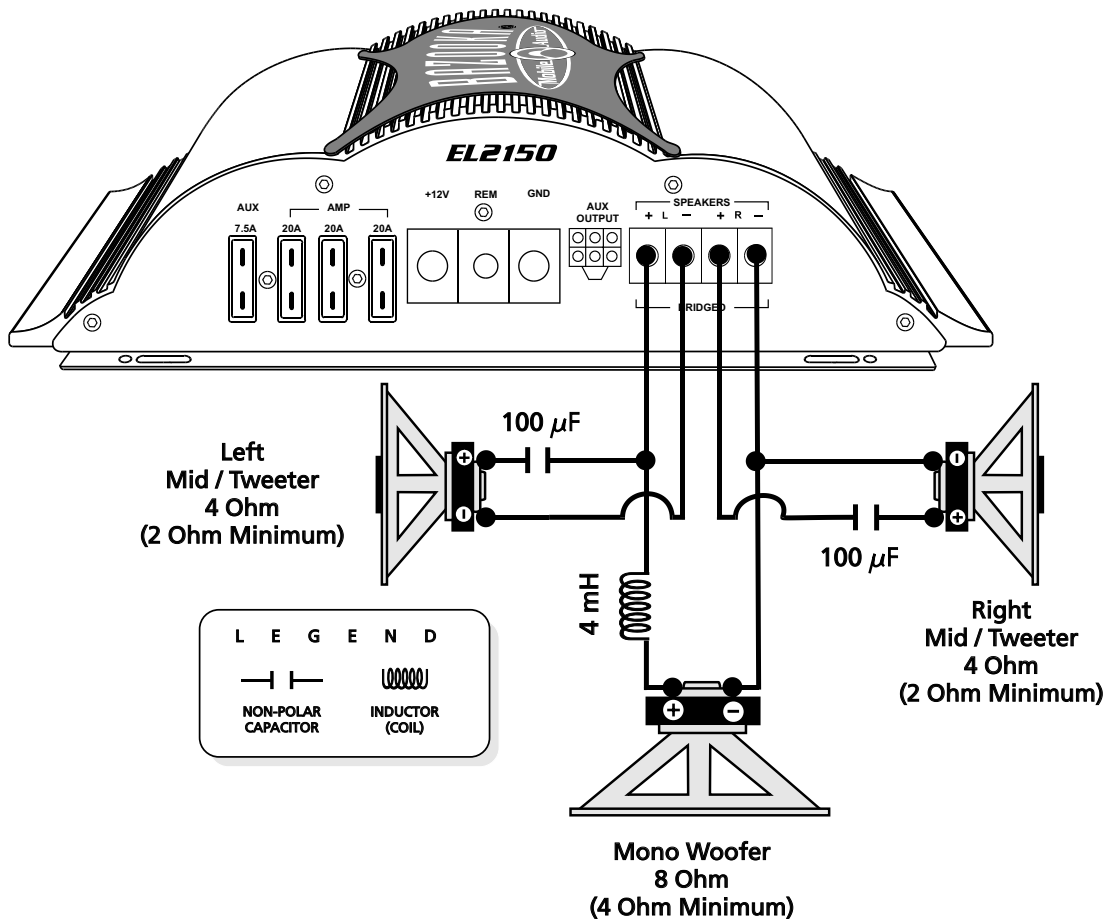

CAUTION! In Tri- mode operation, the amplifier must see a 2 Ohm load or higher for the stereo satellites and no lower than 4 Ohms for the subwoofer(s). Any lower than the above mentioned impedance will cause the amplifier to overheat and possibly cause permanent damage to the amplifier.

REMOTE BASS CONTROL MODULE (OPTIONAL)

Before connecting the remote, it will be necessary to find a mounting location that will be easy to access for adjustment. Once you select your mounting location, you will need to run the control wire from the remote to the amplifier. To avoid possibility of induced noise from the car's electrical system (i.e. popping noises or engine noise), run the cable from the remote to the amplifier away from the car's electrical wiring.

Please note: Once the remote is plugged in, it overrides the bass boost on the amplifier and becomes the primary bass adjustment.

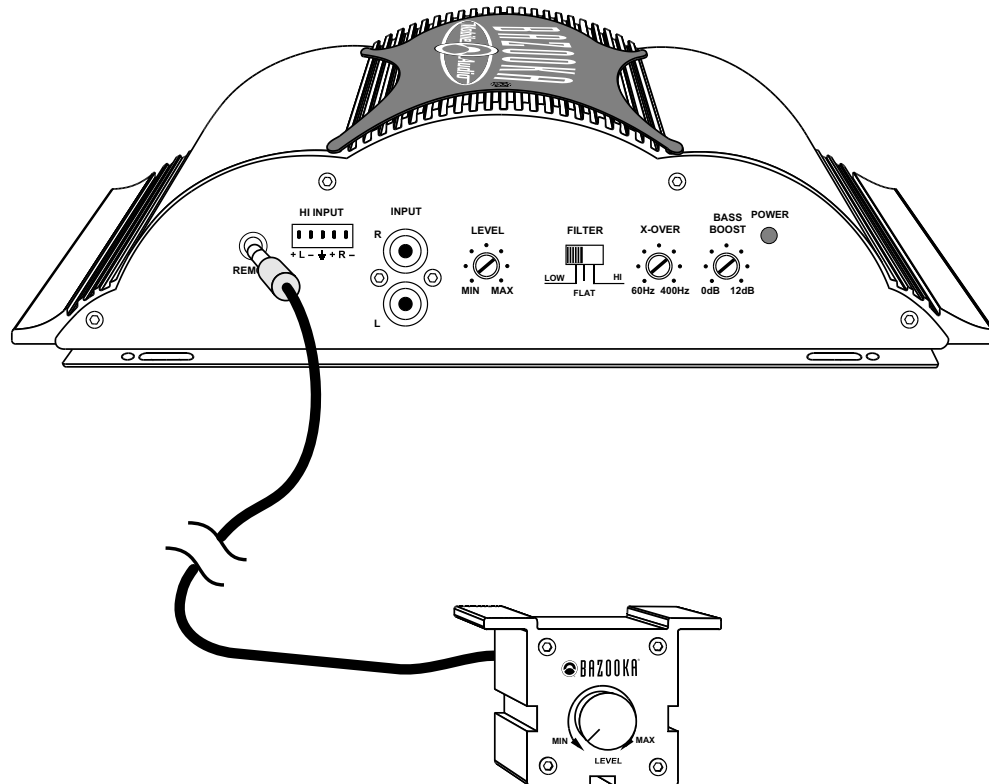

ADJUSTING THE X-OVER AND BASS

(Please note: If you intend to use the amplifier in the Tri-mode configuration, it is necessary to set the crossover control to the "FLAT" setting in order to receive full range output)

The "EL" amplifiers are equipped with a built-in variable crossover network allowing you to select the crossover type (i.e. Low-Pass or Hi-Pass) and the desired crossover point. For example if you wish to drive a pair of subwoofers, you can select the "Low Pass" setting on the amplifier to filter out high frequencies. This will send only low frequencies to your subwoofers (see example settings below). The crossover point should be determined by the speakers operating range. Please refer to speaker manufactures recommended crossover point.

Select the crossover type on the amplifiers side panel.
(Low-pass is selected in this example for subwoofers)

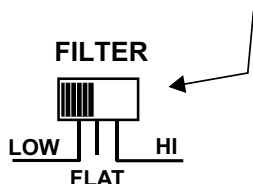

You can add up to 12dB bass boost by increasing the Bass Boost control.



Select the crossover point for your speakers.

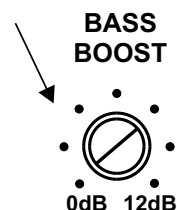

FINE TUNE THE SYSTEM

Fine tune the amplifier's input sensitivity.

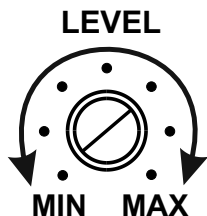

The gain sensitivity control for the "EL" amplifier is located on the side panel. This gain control has been included to allow adjustment to properly match the output of the radio. This is one of the most misunderstood adjustments. By rotating the control in the clockwise direction, the amplifier's input will become more sensitive and the music will play louder.

This is not a volume control and you will not get more power out of the amplifier in the maximum position! It may seem to deliver more output, but actually the system is only playing louder faster as you turn the volume control on the radio. Ideally, to properly level match the system the goal is to achieve maximum output from the amplifier without distortion at about 3/4 of the volume control.

To determine if the amplifier's gain is set properly, turn the system on and slowly increase the volume control. You should be able to use about 3/4 volume before the system gets loud but not distorting. It is very important when making these adjustments that you do not over drive the speakers (at point of distortion) this will cause permanent damage to the speakers. If you are unable to achieve 3/4 volume before distortion you will need to adjust gain control (in this case you would reduce the gain). The gain controls should be adjusted very slowly. It may help to have another person to assist you by adjusting the gain controls while you listen for distortion.

TROUBLE SHOOTING THE SYSTEM

We have put together this trouble-shooting guide if you experience problems after installing the amplifier. Please keep in mind that the majority of problems incurred are caused by improper installation and not the equipment itself. In addition, there are many components in the system that could cause various signal problems such as inducted electrical noise and engine noise.

Before you can properly address the problem, you must first find the component that is causing the problem. This will take patience and a process of elimination.

LOOK FOR....	SOLUTION
No Output	
Blown fuse	Replace
Bad RCA Cable(s)	Replace
+12V at power terminal	Check connection
+12V at remote terminal	Check connection
Grounding point clean and tight	Check for ground w/meter
Head Unit's fader not in center position	Set to center position
Low Output	
Check level adjustments	Re-adjust
Bad RCA cable(s)	Replace
Improper level matching	Re-adjust
Engine Noise	
Grounding points are clean and tight	Check for ground w/meter
Ground all components at same point	Ground at same point
Try different grounding point	Change for better ground
Bad RCA cable(s)	Replace
Use High Quality shielded RCA cables	Rejects inducted noise
Low Vehicle charging system and/or battery	Fix and/or replace
Red Protection L.E.D. Illuminated	
Speaker short	Check speakers connection for short circuit
Speaker grounding out	Make sure speaker wires do not touch chassis ground
Impedance too low	Check speaker impedance (Min 2 ohm Stereo, 4 Mono)
Overheating	Check mounting location for Adequate air Circulation
	Speaker impedance too low

SPECIFICATIONS

	EL260	EL2100	EL2150
Max Power	300W	500W	750W
Output Power @ 14.4 VDC :			
4 ohm	70W x 2	115W x 2	160W x 2
2 ohm	95W x 2	165W x 2	230W x 2
Bridged 4ohm	190W x 1	330W x 1	460W x 1
Frequency Response + - 1dB	20Hz-22KHz	20Hz-22KHz	20Hz-22KHz
S/N Ratio (A-weight)	>90dB	>90dB	>90dB
THD with 80k filter	.03%	.03%	.03%
Low Input Level	200mV-6V	200mV-6V	200mV-6V
Hi Input Level	1.0V-10.0V	1.0V-10.0V	1.0V-10.0V
Battery Voltage Range	10.5VDC-15.0VDC	10.5VDC-15.0VDC	10.5VDC-15.0VDC
Crossover S/W for 1+2 channel	HP/FULL/LP	HP/FULL/LP	HP/FULL/LP
Variable Hi-Low Pass Range	60Hz-400Hz	60Hz-400Hz	60Hz-400Hz
Crossover Slope	12dB/Oct	12dB/Oct	12dB/Oct
Bass EQ at FULL/LP	0-12dB @ 45Hz	0-12dB @ 45Hz	0-12dB @ 45Hz
Unbalanced Input (RCA Jack)	Yes	Yes	Yes
Jack for Remote Control	Yes	Yes	Yes
Aux Fuse Holder & Fuse	7.5A	7.5A	7.5A
Amplifier Fuse & Holder	1 x 20A	2 x 20A	3 x 20A
Size (L x W x H)	8 1/2" x 10 1/4" x 2 5/8"	10 1/4" x 10 1/4" x 2 5/8"	15 3/4" x 10 1/4" x 2 5/8"

	EL1500	EL460	**MA460
Max Power	600W	600W	600W
Output Power @ 14.4 VDC :			
4 ohm	350W x 1	65W x 4	65W x 4
2 ohm	500W x 1	85W x 4	85W x 4
Bridged 4ohm	N/A	175W x 2	175W x 2
Frequency Response + - 1dB	20Hz-200Hz	20Hz-22KHz	20Hz-22KHz
S/N Ratio (A-weight)	>90dB	>90dB	>90dB
THD with 80k filter	.03%	.03%	.03%
Low Input Level	200mV-6V	200mV-6V	200mV-6V
Hi Input Level	1.0V-10.0V	1.0V-10.0V	1.0V-10.0V
Battery Voltage Range	10.5VDC-15.0VDC	10.5VDC-15.0VDC	10.5VDC-15.0VDC
Crossover S/W for 1+2 channel	LP	HP/FULL/LP	HP/FULL/LP
Variable Hi-Low Pass Range	40Hz-200Hz	60Hz-400Hz	60Hz-400Hz
Crossover Slope	12dB/Oct	12dB/Oct	12dB/Oct
Bass EQ at FULL/LP	*0-12dB @ 45Hz	0-12dB @ 45Hz	0-12dB @ 45Hz
Unbalanced Input (RCA Jack)	Yes	Yes	Yes
Jack for Remote Control	Yes	Yes	Yes
Aux Fuse Holder & Fuse	7.5A	7.5A	7.5A
Amplifier Fuse & Holder	4 x 15A	3 x 20A	3 x 20A
Size (L x W x H)	12 1/2" x 10 1/4" x 2 5/8"	12 1/2" x 10 1/4" x 2 5/8"	12 1/2" x 10 1/4" x 2 5/8"

* Low-pass Only

** Marine version of the EL 460, additional features include: Stainless Steel screws, Stainless Steel end plates, marine coated circuit board, gold plated connectors, salt, fog and UV tested.

Due to continuing product improvement, specifications subject to change without notice.



SAS

LIMITED WARRANTY

Southern Audio Services, Inc., warrants all products to be free from defects in material and workmanship for a period of one (1) year from the date of purchase; the Reference Series is warranted for a period of two (2) years from date of purchase. In the event the product is not as warranted, SAS' sole obligation shall be to repair or replace the defective product at SAS' option: SAS limits its obligation under any implied warranties under state laws to a period not to exceed the limited warranty period. SAS and its authorized BAZOOKA® dealers specifically disclaim liability for any incidental or consequential damages. Some states do not allow limitations on how long an implied warranty lasts, and some states do not allow the exclusion or limitation of incidental or consequential damages, so the above limitation or exclusions may not apply to you. This warranty gives you specific legal rights, and you may have other rights, which vary from state to state.

What is covered: This warranty covers all defects in materials or workmanship (parts and labor) in the product.

What is not covered: This warranty does not cover the following:

1. Damages occurring during shipment of the product to SAS for repair (Claims must be presented to the carrier).
2. Damages caused by accident, abuse, negligence, misuse or improper Operation or installation.
3. Damages caused by an act of God, including without limitation, fire, flood Storm or other acts of nature.
4. Any product, which has a serial number, defaced, altered, modified, or removed.
5. Any product that has been altered or modified without SAS' consent.



How to obtain warranty services:

1. You are responsible for delivery of the product to an authorized BAZOOKA® dealer or contact SAS at 1-800-THE TUBE for a Return Authorization number. The Return Authorization number must be clearly written on the outside of the box. Freight must be prepaid to SAS. Warranty replacement parts will be returned freight prepaid. The entire enclosure may be returned for warranty service, but return will be freight collect.
2. You must provide proof of the date of purchase of the product. If proof of purchase is not provided, original date of manufacture will be used to determine warranty period.
3. You must package the product securely to avoid damage during shipment.
4. After acquiring a Return Authorization number, ship to the address below. Please complete this section and retain for your records.

Model(s) purchased _____

Serial number(s) _____

Date Purchased _____

Dealer's name _____



If you have any questions contact the SAS Technical Support Department at:
Phone - 225 272-7135 • Fax 225-272-9844
In Canada: 604-988-2966
e-mail - tech@bazooka.com • Website - www.bazooka.com

 SAS, BAZOOKA, BASS TUBES, and LISTEN TO YOUR EARS
are registered trademarks of Southern Audio Services, Inc.